

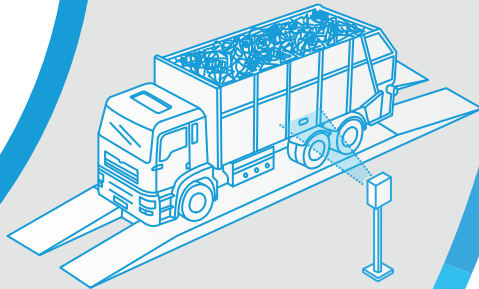

Software solutions for weighing systems

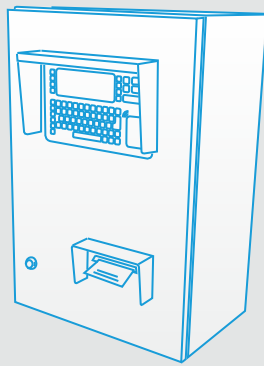

Product Catalogue

GS SOFTWARE - YOUR PARTNER FOR WEIGHING SOFTWARE!

GS Software was founded in 2007. Since the very beginning we have focused on providing high quality software used in weighing processes. Currently we produce software used to handle weighing operations on truck, axis and rail scales (both static and dynamic), belt conveyor scales, palette scales, weighbridges and industrial scales. We also design and implement complete weighing systems in industry and produce electronic components used in weighing processes. The quality of our software has been recognized by leading companies in the weighing sector. Our products are sold under the brand names of several weighing companies with a global reach.

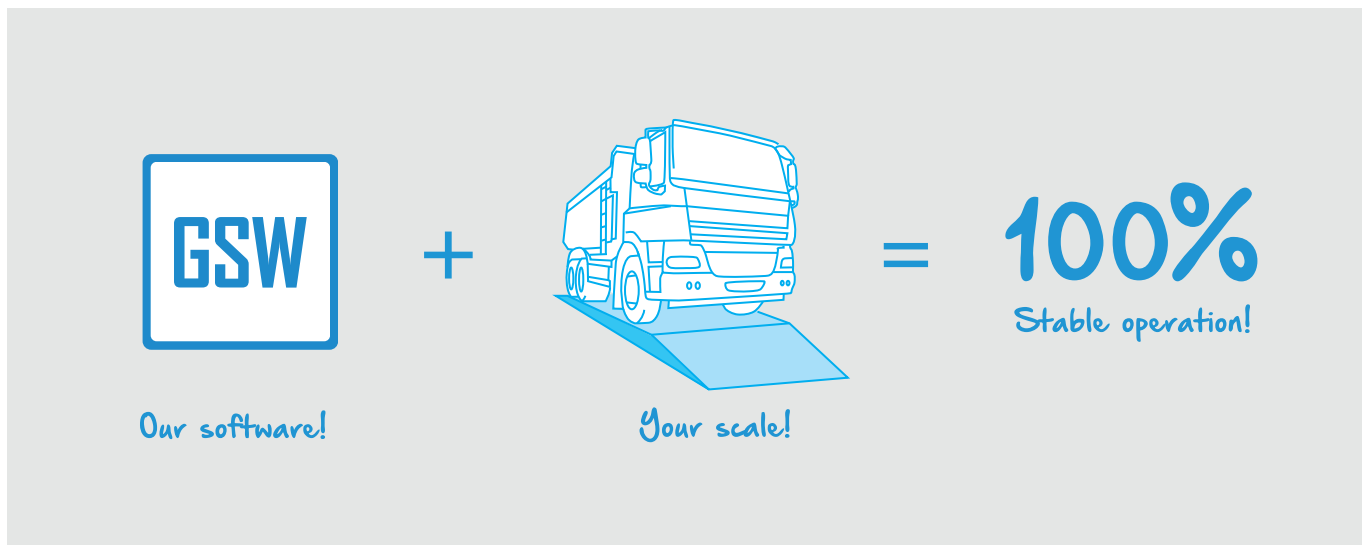

Why choose our software?

- ✓ it is easy to use
- ✓ it operates stably for its entire life-time
- ✓ it can be adapted to support weighing indicators of any manufacturer
- ✓ it supports various types of weighing
- ✓ it cooperates with truck and railway scales
- ✓ the software can be adopted to meet individual requirements (e.g. integration with ERP systems)
- ✓ we guarantee free access to technical support
- ✓ our software is available in multiple language versions - adding new ones is a matter of weeks

GSW STANDARD - SOFTWARE FOR TRUCK AND RAIL SCALES

GSW GSW Standard

GSW is a modern, specialized application, guaranteeing 100% stable operation.

While designing GSW software, we concentrated mainly on making the software user-friendly, we strived to make the program installation, configuration and day-to-day usage as easy as possible. Based on our wide experience, we have created a clear and simple interface - especially important in the common case in which scales are operated by less tech-savvy persons.



✓ Transparent weighing window

The GSW weighing window can be adjusted to the user needs with just several mouse-clicks. Apart from the basic information required for weighing, such as: vehicle registration number, contractor name and product name, up to 10 custom data tables and 8 information fields can be added by the user. Moreover, a live feed from the cameras monitoring the scale enables you to monitor the weighing processes continuously.

The screenshot displays the GSW software interface. On the left, a 'Camera image preview' window shows a live feed of a white MAN truck on a scale. The main window, titled 'Weighing', contains the following data:

WEIGHING FOR	
LBS Process Solutions, Boulevard Arago 38, 75000 Paris	
First weighing (Ctrl+1) Second weighing (Ctrl+2) 15:55:27	
LICENSE PLATE NO.	EN 875NE
SEMITRAILER NO.	WW 5678A
TARE	0 kg
TYPE	Goods Received Note
CUSTOMER	ASK TECHNOLOGY
PRODUCT	IRON AND STEEL
ORDER NUMBER	RE-198/2015
DRIVER'S NAME	ALBERT WEST
COMMENTS	
ENTRANCE	
EXIT	
NET	46100
NET DECLARED	0
46100 kg WEIGH IN -0-	
List of first weighings List of weighings Datasets Report Print	
1 ↑ ✕	
ONLINE HELP	

THE PROGRAM'S ADDITIONAL MODULES

The main features of the program include:

- ✓ Truck scale and rail scale operation
- ✓ Simultaneous handling of 3 scales
- ✓ Possibility to activate additional modules
- ✓ Camera handling - automatic snapshots of weighings
- ✓ Handling of self-service driver terminals
- ✓ Advanced report generator
- ✓ Graphical weighing tickets editor
- ✓ Configurable database
- ✓ RFID card readers handling
- ✓ Handling of external devices, e.g. traffic lights and barriers

Additional modules available in the program

 <p>Vehicle location on the weighbridge control module</p> <p>Control of a vehicle's location on the weighbridge with infrared barriers or optical sensors allows to maintain the correct position of the vehicle during the weighing process. The mechanism verifies the vehicle's location on the weighbridge, ensuring that none of the axes is outside the weighbridge.</p>	 <p>Weighing with packaging/containers module</p> <p>This module allows you to freely determine the type of the packaging received/delivered depending on the company's business profile. They can be e.g. pallets, wooden crates, metal baskets, pallet collars, plastic packaging and containers. Specific weight may be assigned to each of the user-defined packaging.</p>
 <p>Traffic light and barrier control module</p> <p>This module allows you to control external devices, such as traffic lights or barriers, from the GSW user window, or following a predefined, automatic weighing process.</p>	 <p>Contamination handling module</p> <p>Before weighing, the user can specify the level of contamination. The contamination can be specified either in percentage or kilograms. The program then calculates the net weight automatically, which is then reduced by the contamination value.</p>
 <p>Weighbridge monitoring module (registering an object's presence on the weighbridge)</p> <p>This module continuously monitors the scales. In case a mass change greater than 400 kg is detected, and no weighing or tare weighing is performed, the event is logged, and snapshots from the cameras assigned to the scales are taken.</p>	 <p>Warehouse handling module</p> <p>In this module you can create any number of warehouses in the weighing program and perform warehouse operations, such as acceptance/external release, material movement, etc. The operations can relate to any warehouse or any product.</p>
 <p>Access to data via the Internet</p> <p>This module allows you to access the database of performed weighings and pictures via the Internet and also allows you to generate reports of the accomplished weighings. Using this module, a weighbridge owner can preview the weighing processes using a device connected to the Internet, e.g. a tablet, smartphone or a remote workstation.</p>	 <p>SMS sending module</p> <p>This module allows you to receive text messages to a predefined phone number based on predefined triggers concerning the weighbridge, e.g. when a vehicle leaves the weighbridge without a weighing being performed.</p>

OPERATION OF MULTIPLE WEIGHING SCALES AND DEPARTMENTS

✓ Operation of three weighing scales

The GSW Standard solution installed on one workstation can handle up to three weighing indicators. Each of the scales can perform single, double (entry/exit) and multiple weighing, compound weighing (long vehicles on short scales), service weighing and taring weighing. It is possible to handle truck scales and rail scales from a single workstation.

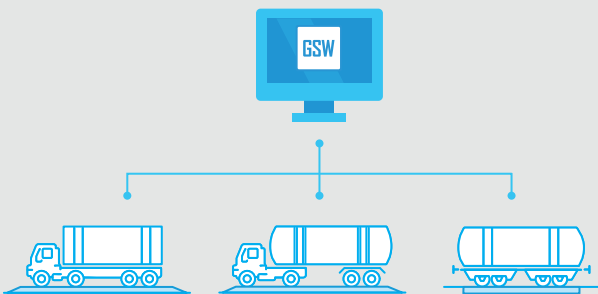

✓ Networking

GSW applications can be combined into any number of workstations within a company's local network. The use of a modern, fast and highly efficient SQL server allows for smooth operation in the networked environment, as well as safe collection of vast amounts of data. The program has successfully been implemented in multi-branch corporations, handling more than 100,000 weighings a year.

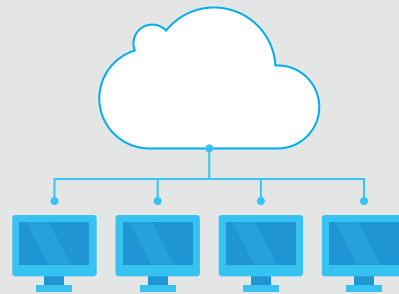

✓ Cooperation with weight indicators

GSW supports over 80 weighing indicator models from a variety of manufacturers. Supported communication modes include RS 232/RS 485 or and TCP/IP. Moreover, our support team swiftly responds to customer requests to add support for further weighing indicator models – free of additional charges. Our list of supported devices constantly keeps on growing!

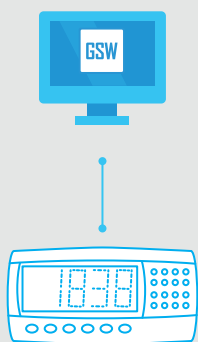

✓ Camera handling

GSW includes an advanced video engine, allowing to simultaneously connect to 12 cameras. Live feed from the cameras is visible in the weighing window, while snapshots of all weighings are saved into the database.

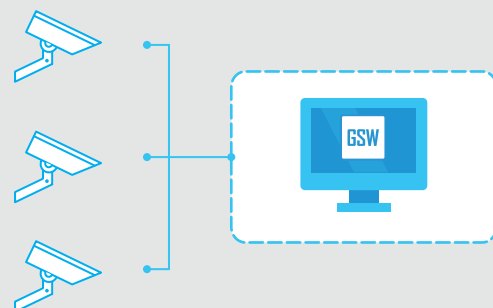

AUTOMATED WEIGHING SYSTEMS

GS Software is a producer of a wide range of systems, used in automated weighing processes. Bearing in mind the needs of our customers, we can supply systems for automated weighing, customized to fit individual requirements.

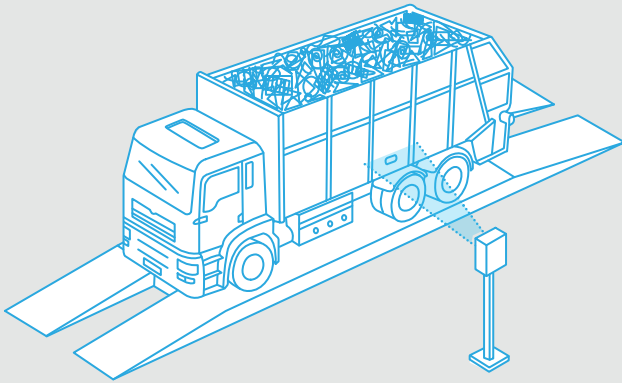

Our offer includes:

- ✓ Weighing systems with RFID card readers
- ✓ Weighing systems with self-service driver terminals
- ✓ Remotely operated vehicle weighing systems
- ✓ Weighing systems with barcode readers
- ✓ Weighing systems with short range and mid-range RFID tags
- ✓ Weighing systems with the weighed vehicle's number plate recognition
- ✓ Weighing systems with sea container number (SOLAS) recognition

✓ Systems integration

Our company specializes in integrating weighing systems with ERP systems (e.g. SAP, Microsoft Dynamics NAV, Microsoft Dynamics AX).

Hundreds of customers have trusted our expertise, which resulted with a broad range of successful projects, and a confidence in our ability to handle all sorts of challenges accompanying system integrations.



*All trademarks belong to their respective owners.

WEIGHING SYSTEMS WITH NUMBER PLATE RECOGNITION

One of our expertise areas includes the design of weighing systems with number plate recognition. For this reason, the GSW software implements a powerful mathematical engine, which recognizes number plates.

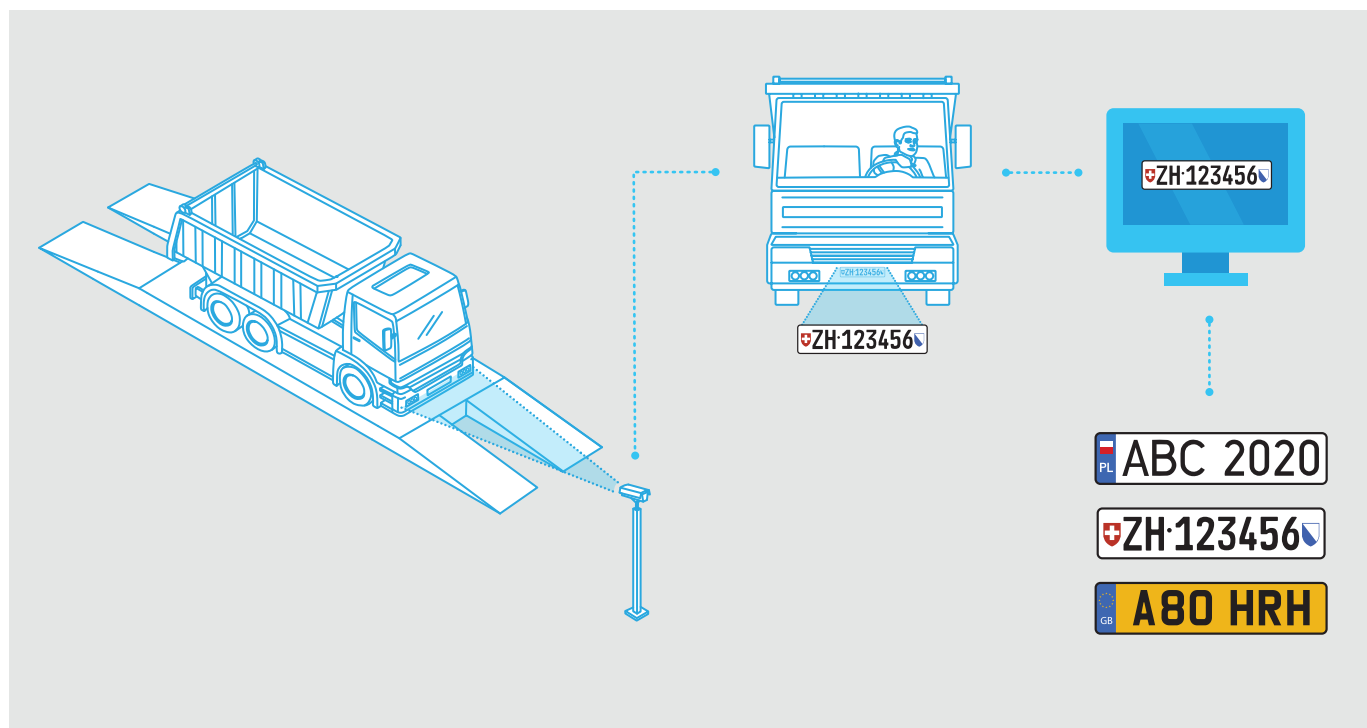

Advantages of ANPR systems:

- ✓ No human supervision required to operate the scales
- ✓ Recognition effectiveness exceeding 95%
- ✓ Increase of the scale's capacity - the entire weighing process only takes 15~20 seconds
- ✓ Increase of work safety - the driver does not need to leave the vehicle

STX-SERIES SELF-SERVICE DRIVER TERMINALS

GS Software manufactures self-service terminals which, combined with GSW software solutions, help streamlining weighing processes on a truck scale.

Using the terminal, the driver can autonomously perform weighing by providing/selecting the required pieces of information (e.g. type of delivered product, order no.). The terminal can be logged into by swiping a previously provided RFID card, entering a unique code assigned to each driver, or based on the license plate number of the weighted vehicle.



STX 5000 Self-service terminal



The STX 5000 self-service terminal can be used to create a variety of automated weighing systems. The terminal is equipped with a high-brightness, clear TFT display, enabling operation in direct sunlight. The alphanumeric keyboard mounted on the terminal is equipped with large keys for easy text entry by the user. The terminal has the ability to read RFID cards. STX 5000 can additionally be equipped with a weighing ticket printer and intercom to contact the scale operators (with HD sound quality).

The terminal additionally supports the operation of following equipment:

- ✓ Traffic lights
- ✓ Barriers
- ✓ LED displays
- ✓ Infrared barriers
- ✓ IP cameras

STX SERIES RFID CARD READERS

Using the STX 1000 and STX 2000 readers, the GSW software can perform weighing processes with the use of RFID cards or with a designated ID codes, assigned to each driver (STX 2000).

The readers are equipped with digital I/O modules enabling the control of external devices such as traffic lights or barriers.

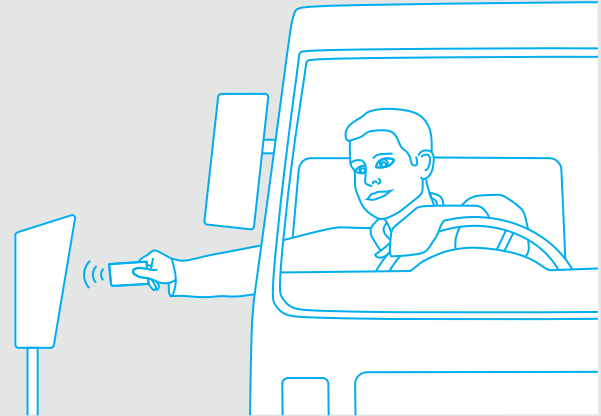

STX 1000
RFID card reader



STX 1000 is an uncomplicated and reliable RFID card reader. RFID card reading is confirmed by a beep, while weighing completion is confirmed with a clearly displayed "OK" sign.



STX 2000
RFID card reader



STX 2000 is equipped with an OLED display, a numeric keypad, and a RFID card reader. The weighing process is initiated by placing the card in the proximity of the reader, or by entering of a PIN code. The reader also allows you to select the type of product to be weighed.

OUR PROJECTS IN PRACTICE





